



**BONGARD**

*Always by your side*



ELECTRIC DECK OVENS

# ORION EVO

Controlled  
quality baking



MADE IN FRANCE



The **ORION EVO** range of electric deck ovens, Bongard's best-seller, comes with 3 to 5 decks, in 1 or 2 tracks of 600 or 800 mm for deck depths between 120 to 240 cm.

Highly responsive, the **ORION EVO** maintains production output rates with precise energy consumption management.

With state of the art technology, it offers an unparalleled level of excellence in the **control** and **precision** of baking and pastry products.

The true brain of the oven is its INTUITIV'2 control unit, which manages all the decks and makes baker and pastry chef's lives easier, from programming recipes, to delayed start baking and independent baking management.

Multi-purpose, it is ideal for cooking all types of dough, whether fresh, cold (namely if you work with the PANEOTRAD® method) or frozen raw dough.



Performance

Reactive

Lasting

Multi-purpose  
Intelligence





## Excellent baking quality

**ORION EVO** has an unparalleled level of excellence in the **control** and **precision** in baking products.

The absence of temperature interference between decks, made possible by reinforced sealing and thermal insulation, ensures **perfect baking consistency**. Different types of breads and pastry products can be cooked simultaneously.

High quality **steam** is produced in **just the right amount** thanks to one steam generator per deck and precise settings in millilitres.

Available as an option, the **motorised steam vent** is **highly recommended** for pastry products such as meringues, macarons, choux or puff pastry which it helps to dry. It is also useful at the end of baking bread.

The **ORION EVO** can be equipped with a **ROC deck** (Optimised Baking Radiation). Its 4 refractory hearth plates on all sides of the cooking chamber increase the thermal inertia just like in an old-fashioned oven. The heat is gentle and particularly adapted to provide **large pieces of dough** with a **thick crust**.



## Tips from our bakers and pastry chefs



For optimum baking in an electric deck oven, the top temperature must be slightly higher than the bottom with a difference of between **5** and **15°C**.



## An oven that keeps up with the pace

Ovens from the **ORION EVO** range can bake up to 15 kg of cold dough an hour per m<sup>2</sup> of deck. For example: including loading and unloading time, an oven with one 800mm track and four decks 160cm deep can bake 215 baguettes per hour.

A “boosted baking capacity” option is also available. Ideal for quick baking and/or with an increased load of dough, this option makes it possible to bake up to **18 kg of dough an hour per m<sup>2</sup> of deck.**

**ORION EVO** is **highly responsive**. Its power coupled with excellent chamber insulation allows a rapid increase in temperature which it maintains over time. The oven is **quickly ready** to restock the shelf throughout the day.



## Tips from our bakers and pastry chefs



For continuous baking times of less than 15 minutes, the boosted capacity option is recommended.

## Precise energy consumption management

With **ORION EVO**, particular attention has been paid to controlling energy consumption in order **to optimise its operating costs**.

The reinforced leaktightness of the windows and the addition of a high-performance reflective treatment on the inner surface of the glass **greatly reduces heat loss in the baking opening**.

The INTUITIV'2 control panel ensures centralised energy management. The **power is automatically assigned to where it is needed** without user involvement.

The **"Delayed start"** function is used to define the precise minute at which a deck must be at temperature to start the programmed recipe. Precise energy management for **greater usability**.

The **"Energy Saving"** function automatically manages putting the decks on stand-by, after a defined time, when not being used. A **waste in energy consumption** is thus **avoided**.



## Tips from our bakers and pastry chefs



Manual steam injection before loading is not advised. This steam could escape when the door opens, causing energy waste and unwanted costs. The **Recipes mode is used to very simply set** steam injection at the start of each bake and/or other moments if needed.



# ORION EVO has been designed to make your life easier

## Enhanced steam system:

The steam is distributed evenly throughout the baking chamber, **without the risk of water splashing**, thanks to a diffuser on the outside of the reinforced casing. A decompression valve, ensuring **optimum durability**, completes the system.



## Motorised Oura Vent (optional):

The motorised vent, which can be programmed using the INTUITIV'2 control panel, is used to **control steam evacuation** during baking.

## Easy window maintenance:

The windows can be tilted to make **cleaning quick and easy**. They can also be disassembled without tools.



## Optimised cleaning:

The "smooth deck" design of the oven mouth (patented by Bongard) allows **quick and efficient cleaning** of the baking chamber.

To avoid all risk of deterioration during this operation, the sensors in the roof are equipped with a protection system.

## INTEGRATED lifter LIFT'EVO (optional):

For greater ease of use, ORION EVO can be equipped with an integrated lifter LIFT'EVO with its dedicated loader/unloader.

Adjustable to the user's working height, it **promotes better posture**. Electric assistance is also available on some models.

**With ORION EVO, work in complete safety**



Our commitment to safety goes beyond self-certification since we have our equipment audited by an external independent body. Our equipment complies with all current standards.

## Intuitive and smooth control panel

The **ORION EVO** range is provided with the INTUITIV'2 touch control panel as standard, which intelligently manages the decks of the oven via its 10 inch screen.

Its clear and simple interface makes it very easy to use and offers a wide range of settings.

Depending on your needs, the oven can also be equipped with an electromechanical Ergocom control panel on each deck.



**Baking management**  
in manual mode or  
in Recipe mode

**Recipe creation**  
(temperature, duration,  
steam injection  
and oven vents operation)

**Scheduling of delayed  
baking start-ups per  
deck and per day**

**Personalised rights management**  
according to user profiles (recipe  
modification authorised or not, etc.)

**Access to the  
"Energy Saving" function**

**Consultation of the oven production  
and energy statistics**

**Temporary deactivation of the  
touchscreen for cleaning the control  
unit's protective glass**

# Our experts at your service

## Our sales expertise

Our sales and installation teams are here to help you carry out your project: they offer equipment and bakery layout recommendations adapted to your production process.

For the French market, we also offer a service dedicated to financial leasing: Bongard Finance. An agile financing method that preserves cash flow, a first in the bakery and pastry goods market.

## Our business expertise

Our 320 m<sup>2</sup> showroom and laboratory at our head office in Holtzheim is available on request for you to test our equipment according to your own manufacturing process.

Our expert master bakers come to your bakeries, at your request, all over the world, to train you on our machines.

## Our technical expertise

Our equipment is covered by the manufacturer's warranty from the moment of delivery. You can choose a maintenance contract associated with an extended warranty in order to sustainably optimise the operation of your equipment and avoid costly downtime.

BONGARD provides training to technicians from dealerships and distributors in order to ensure the proper functioning and durability of your equipment. Our dealers and distributors have access to an online platform containing technical information and allowing them to order some 5,000 references of original spare parts, shipped within 24 to 48 hours.





# ORION EVO Technical Data

|  | ORION EVO  |
|--|------------|
| <b>Access to resistors / steam generator / handle side / control unit side</b> |            |
| All on the left  | •          |
| All on the right   | 0          |
| <b>Control units</b>   |            |
| INTUITIV'2 control unit (1 central control unit)                               | •          |
| ERGOCOM control unit (1 control per deck for oven with 3- 4 decks)             | 0          |
| ERGOCOM control unit (1 control per deck for oven with 5 decks)                | €          |
| <b>Baking deck equipment</b>   |            |
| 4 <sup>th</sup> ROC deck, including oura vent                                  | €          |
| Decompression on each deck (except the ROC deck)                               | •          |
| Motorised steam vent on the upper deck   | €          |
| Motorised steam vent on each deck  | €          |
| Resistor protection system in the top  | •          |
| Opening compatible with a bottom hook loader-unloader                          | €          |
| <b>Baking capacity/energy management (only with INTUITIV'2)</b>                |            |
| Centralised energy management  | •          |
| Boosted baking capacity  | €          |
| Energy management optimiser  | €          |
| GTC system compatibility   | •          |
| <b>Scalability</b>   |            |
| 3-deck oven scalable up to 4 decks (to be specified when ordering)             | €          |
| 4 <sup>th</sup> deck kit ( to assemble later)                                  | €          |
| <b>Steam</b>   |            |
| Pulsating steam injection  | •          |
| 1 water meter per steam generator (Intuitiv'2 only)                            | •          |
| Anti-scale filter fitted with 1 cartridge                                      | •          |
| Without water filter to prevent scale deposits                                 | -€         |
| Pressure reducer kit   | •          |
| <b>Accessories</b>   |            |
| Bench (excl. 5-deck oven)  | •          |
| Hood with exhaust fan and lighting   | •          |
| Oven hook system   | €          |
| Integrated lifter LIFT'EVO (with loader repositioning system)                  | €          |
| Motorised integrated lifter LIFTED (only for 1 x 800mm)                        | €          |
| Stainless steel loader   | €          |
| <b>Panels</b>  |            |
| Stainless steel front with metal side panels in pre-lacquered grey steel       | •          |
| Full stainless steel oven housing  | €          |
| <b>Assembly</b>  |            |
| Oven to be assembled on site   | •          |
| Base 12 mm   | €          |
| Oven shipped mounted on a base   | Consult us |
| <b>Power supply voltage</b>  |            |
| 3N~400 V   | •          |



## ORION EVO - Black Edition



To celebrate our centenary, a special edition of the **ORION EVO** oven is available as a 1-track 800 mm, 4 deck, with optional integrated lifter.

Its black design, embellished with the "Since 1922" golden label, adds a touch of elegance to any bakery.

The series is numbered and limited to 100 ovens.

# ORION EVO Technical Data

| Technical features                      |               |             |            |                |                     |                     |                                   |   |                   |            |  |                              |
|---|---------------|-------------|------------|----------------|---------------------|---------------------|-----------------------------------|---|-------------------|------------|--|------------------------------|
| Models                                  | Overall depth | Floor depth | Oven width | Overall height | Frontal oven height | Oven + loader depth | Oven depth with integrated lifter | Height with integrated lifter (excluding loader + stop) | Baking area       | Floor area | Total weight of the empty assembled oven, no base, no option | Connection power             |
|   | A             | B           | C          | D              | E                   | F                   | G                                 | H   | (m <sup>2</sup> ) |            | (kg)   |                              |
| (mm)                                    |               |             |            |                |                     |                     |                                   |   |                   |            |  |                              |
| <b>ORION EVO - 1 x 800 mm - 3 decks</b> |               |             |            |                |                     |                     |                                   |   |                   |            |  |                              |
| 801/3.120                               | 2252          | 2204        |            |                |                     | 4226                |                                   |   | 2.8               | 3.2        | 1447   | Standard electricity tariff  |
| 801/3.160                               | 2666          | 2618        |            |                |                     | 5010                |                                   |   | 3.8               | 3.8        | 1638   | Standard electricity tariff  |
| 801/3.180                               | 2878          | 2830        | 1441       | 2682           | 2200                | 5593                | 1645                              | 2301  | 4.3               | 4.1        | 1868   | Standard electricity tariff  |
| 801/3.200                               | 3072          | 3024        |            |                |                     | 5802                |                                   |   | 4.8               | 4.4        | 1949   | Standard electricity tariff  |
| 801/3.220                               | 3282          | 3234        |            |                |                     | 6386                |                                   |   | 5.3               | 4.7        | 2035   | Standard electricity tariff  |
| 801/3.240                               | 3477          | 3429        |            |                |                     | 6580                |                                   |   | 5.8               | 5.0        | 2140   | Standard electricity tariff* |
| <b>ORION EVO - 1 x 800 mm - 4 decks</b> |               |             |            |                |                     |                     |                                   |   |                   |            |  |                              |
| 801/4.120                               | 2252          | 2204        |            |                |                     | 4226                |                                   |   | 3.8               | 3.2        | 1857   | Standard electricity tariff  |
| 801/4.160                               | 2666          | 2618        |            |                |                     | 5010                |                                   |   | 5.1               | 3.8        | 2109   | Standard electricity tariff  |
| 801/4.180                               | 2878          | 2830        | 1441       | 2682           | 2200                | 5593                | 1645                              | 2301  | 5.8               | 4.1        | 2422   | Standard electricity tariff* |
| 801/4.200                               | 3072          | 3024        |            |                |                     | 5802                |                                   |   | 6.4               | 4.4        | 2520   | Standard electricity tariff* |
| 801/4.220                               | 3282          | 3234        |            |                |                     | 6386                |                                   |   | 7.1               | 4.7        | 2646   | Consult us                   |
| 801/4.240                               | 3477          | 3429        |            |                |                     | 6580                |                                   |   | 7.7               | 5.0        | 2770   | Consult us                   |
| <b>ORION EVO - 1 x 800 mm - 5 decks</b> |               |             |            |                |                     |                     |                                   |   |                   |            |  |                              |
| 801/5.120                               | 2242          | 1812        |            |                |                     | 4226                |                                   |   | 4.8               | 2.6        | 2338   | Standard electricity tariff* |
| 801/5.160                               | 2656          | 2226        |            |                |                     | 5010                |                                   |   | 6.4               | 3.2        | 2630   | Standard electricity tariff* |
| 801/5.180                               | 2868          | 2438        | 1441       | 2682           | 2200                | 5593                | 1645                              | 2301  | 7.3               | 3.5        | 3089   | Consult us                   |
| 801/5.200                               | 3062          | 2632        |            |                |                     | 5802                |                                   |   | 8.1               | 3.8        | 3204   | Consult us                   |
| 801/5.220                               | 3272          | 2842        |            |                |                     | 6386                |                                   |   | 8.9               | 4.1        | 3350   | Consult us                   |
| 801/5.240                               | 3467          | 3037        |            |                |                     | 6580                |                                   |   | 9.7               | 4.4        | 3475   | Consult us                   |
| <b>ORION EVO - 2 x 600 mm - 3 decks</b> |               |             |            |                |                     |                     |                                   |   |                   |            |  |                              |
| 602/3.120                               | 2252          | 2204        |            |                |                     | 4242                |                                   |   | 4.3               | 4.2        | 1852   | Standard electricity tariff  |
| 602/3.160                               | 2666          | 2618        |            |                |                     | 5026                |                                   |   | 5.8               | 4.9        | 2103   | Standard electricity tariff* |
| 602/3.180                               | 2878          | 2830        | 1889       | 2682           | 2200                | 5608                | 2093                              | 2301  | 6.5               | 5.3        | 2469   | Standard electricity tariff* |
| 602/3.200                               | 3072          | 3024        |            |                |                     | 5802                |                                   |   | 7.2               | 5.7        | 2615   | Standard electricity tariff* |
| 602/3.220                               | 3282          | 3234        |            |                |                     | 6401                |                                   |   | 7.9               | 6.1        | 2713   | Consult us                   |
| 602/3.240                               | 3477          | 3429        |            |                |                     | 6596                |                                   |   | 8.6               | 6.5        | 2824   | Consult us                   |
| <b>ORION EVO - 2 x 600 mm - 4 decks</b> |               |             |            |                |                     |                     |                                   |   |                   |            |  |                              |
| 602/4.120                               | 2252          | 2204        |            |                |                     | 4268                |                                   |   | 5.8               | 4.2        | 2414   | Standard electricity tariff* |
| 602/4.160                               | 2666          | 2618        |            |                |                     | 5052                |                                   |   | 7.7               | 4.9        | 2762   | Consult us                   |
| 602/4.180                               | 2878          | 2830        | 1889       | 2682           | 2200                | 5634                | 2093                              | 2301  | 8.6               | 5.3        | 3300   | Consult us                   |
| 602/4.200                               | 3072          | 3024        |            |                |                     | 5828                |                                   |   | 9.6               | 5.7        | 3460   | Consult us                   |
| 602/4.220                               | 3282          | 3234        |            |                |                     | 6427                |                                   |   | 10.6              | 6.1        | 3602   | Consult us                   |
| 602/4.240                               | 3477          | 3429        |            |                |                     | 6622                |                                   |   | 11.5              | 6.5        | 3756   | Consult us                   |
| <b>ORION EVO - 2 x 600 mm - 5 decks</b> |               |             |            |                |                     |                     |                                   |   |                   |            |  |                              |
| 602/5.120                               | 2242          | 1812        |            |                |                     | 4268                |                                   |   | 7.2               | 3.4        | 3107   | Consult us                   |
| 602/5.160                               | 2656          | 2226        |            |                |                     | 5052                |                                   |   | 9.6               | 4.2        | 3478   | Consult us                   |
| 602/5.180                               | 2868          | 2438        | 1889       | 2682           | 2200                | 5634                | 2093                              | 2301  | 10.8              | 4.6        | 4291   | Consult us                   |
| 602/5.200                               | 3062          | 2632        |            |                |                     | 5828                |                                   |   | 12                | 5.0        | 4482   | Consult us                   |
| 602/5.220                               | 3272          | 2842        |            |                |                     | 6427                |                                   |   | 13.2              | 5.4        | 4648   | Consult us                   |
| 602/5.240                               | 3467          | 3037        |            |                |                     | 6622                |                                   |   | 14.4              | 5.7        | 4829   | Consult us                   |

6 deck depth choices: 120, 160, 180, 200, 220 and 240cm

\* with INTUITIV'2 and power reduction enabled



# ORION EVO Technical Data

## Technical features

| Models                                  | Overall depth | Floor depth | Oven width | Overall height | Frontal oven height | Oven + loader depth | Oven depth with integrated lifter | Height with integrated lifter (excluding loader + stop) | Baking area       | Floor area | Total weight of the empty assembled oven, no base, no option | Connection power             |
|---|---------------|-------------|------------|----------------|---------------------|---------------------|-----------------------------------|---|-------------------|------------|--|------------------------------|
|   | A             | B           | C          | D              | E                   | F                   | G                                 | H   | (m <sup>2</sup> ) | (kg)       |  |                              |
| <b>ORION EVO - 2 x 800 mm - 3 decks</b> |               |             |            |                |                     |                     |                                   |   |                   |            |  |                              |
| 802/3.120                               | 2252          | 2204        |            |                |                     | 4242                |                                   |   | 5.7               | 5.2        | 1811   | Standard electricity tariff* |
| 802/3.160                               | 2666          | 2618        |            |                |                     | 5026                |                                   |   | 7.7               | 6.1        | 2125   | Standard electricity tariff* |
| 802/3.180                               | 2878          | 2830        | 2345       | 2682           | 2200                | 5608                | 2549                              | 2301  | 8.7               | 6.6        | 2314   | Consult us                   |
| 802/3.200                               | 3072          | 3024        |            |                |                     | 5802                |                                   |   | 9.7               | 7.1        | 2474   | Consult us                   |
| 802/3.220                               | 3282          | 3234        |            |                |                     | 6401                |                                   |   | 10.7              | 7.6        | 2612   | Consult us                   |
| 802/3.240                               | 3477          | 3429        |            |                |                     | 6596                |                                   |   | 11.6              | 8.0        | 2777   | Consult us                   |
| <b>ORION EVO - 2 x 800 mm - 4 decks</b> |               |             |            |                |                     |                     |                                   |   |                   |            |  |                              |
| 802/4.120                               | 2252          | 2204        |            |                |                     | 4242                |                                   |   | 7.7               | 5.2        | 2143   | Consult us                   |
| 802/4.160                               | 2666          | 2618        |            |                |                     | 5026                |                                   |   | 10.3              | 6.1        | 2555   | Consult us                   |
| 802/4.180                               | 2878          | 2830        | 2345       | 2682           | 2200                | 5608                | 2549                              | 2301  | 11.7              | 6.6        | 2765   | Consult us                   |
| 802/4.200                               | 3072          | 3024        |            |                |                     | 5802                |                                   |   | 12.9              | 7.1        | 2965   | Consult us                   |
| 802/4.220                               | 3282          | 3234        |            |                |                     | 6401                |                                   |   | 14.3              | 7.6        | 3177   | Consult us                   |
| 802/4.240                               | 3477          | 3429        |            |                |                     | 6596                |                                   |   | 15.5              | 8.0        | 3360   | Consult us                   |
| <b>ORION EVO - 2 x 800 mm - 5 decks</b> |               |             |            |                |                     |                     |                                   |   |                   |            |  |                              |
| 802/5.120                               | 2242          | 1812        |            |                |                     | 4242                |                                   |   | 9.6               | 4.2        | 2496   | Consult us                   |
| 802/5.160                               | 2656          | 2226        |            |                |                     | 5026                |                                   |   | 12.9              | 5.2        | 2984   | Consult us                   |
| 802/5.180                               | 2868          | 2438        | 2345       | 2682           | 2200                | 5608                | 2549                              | 2301  | 14.6              | 5.7        | 3216   | Consult us                   |
| 802/5.200                               | 3062          | 2632        |            |                |                     | 5802                |                                   |   | 16.2              | 6.2        | 3473   | Consult us                   |
| 802/5.220                               | 3272          | 2842        |            |                |                     | 6401                |                                   |   | 17.9              | 6.7        | 3723   | Consult us                   |
| 802/5.240                               | 3467          | 3037        |            |                |                     | 6596                |                                   |   | 19.4              | 7.1        | 3961   | Consult us                   |

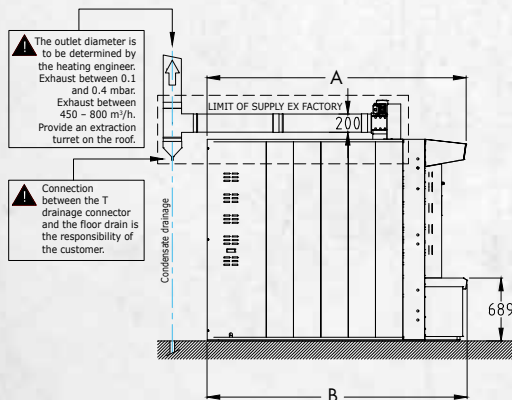

SIDE VIEW WITHOUT INTEGRATED LIFTER

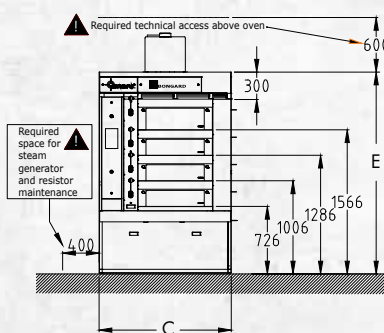

FRONT VIEW WITHOUT INTEGRATED LIFTER

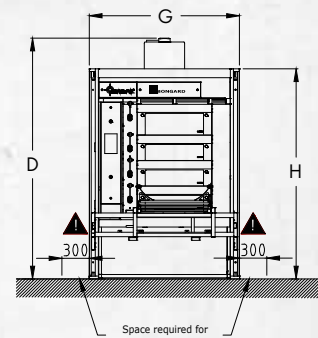

FRONT VIEW WITH INTEGRATED LIFTER

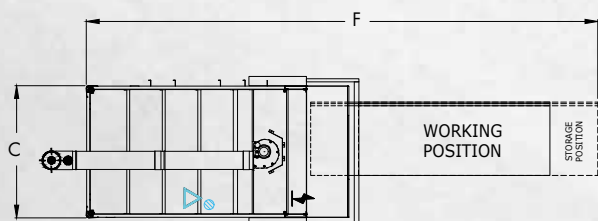

TOP VIEW WITH INTEGRATED LIFTER

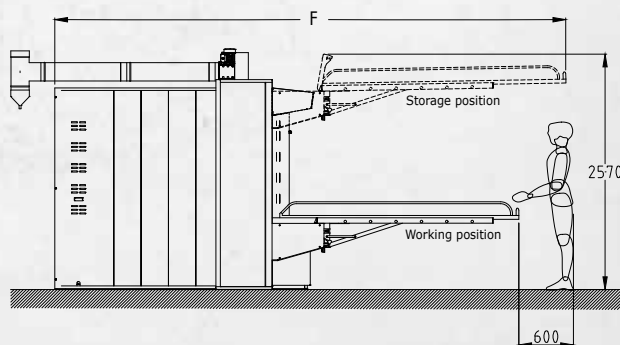

SIDE VIEW WITH INTEGRATED LIFTER



# BONGARD

*Always by your side*

**BONGARD**, French manufacturer of bakery equipment since 1922, relies on a network of exclusive dealers continuously trained on all our ranges to ensure 7/365 commercial and technical service throughout France and the French overseas departments and territories. **BONGARD** is also distributed in more than 140 countries around the world.

To find a distributor near you, please go to:  
<https://www.bongard.fr/en/distributor/>

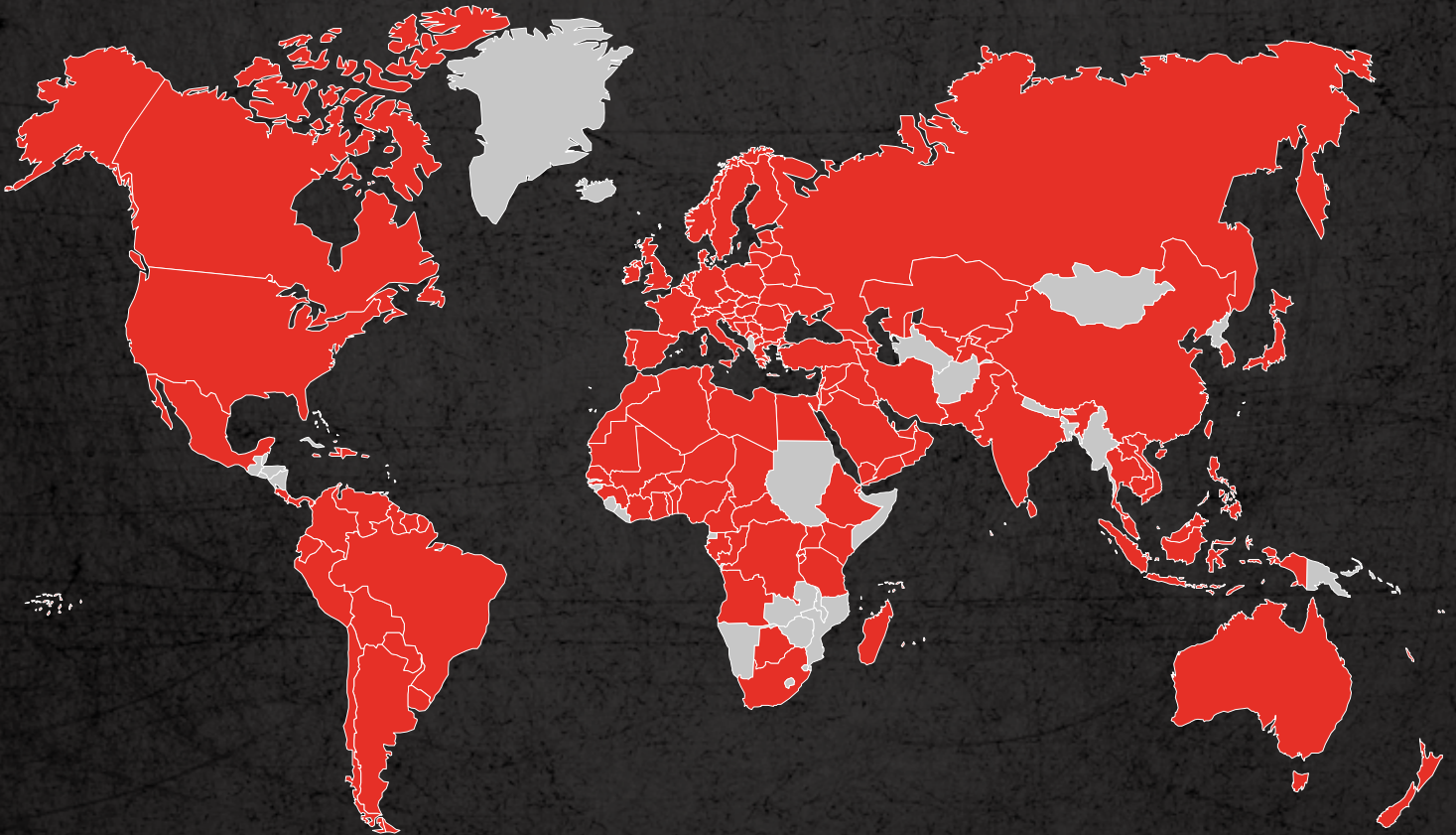

Follow us:

 Bongard.bakery

 Bongard\_bakery

 BongardBakery

 Bongard

## BONGARD

32 route de Wolfisheim - 67810 HOLTZHEIM (France) - Tel. +33 3 88 78 00 23 - [www.bongard.fr](http://www.bongard.fr) - [bongard@bongard.fr](mailto:bongard@bongard.fr)

an Ali Group Company



The Spirit of Excellence